

Standard / Armless

2-Piece Curve Sectional / Ottomans

v.12.02.13

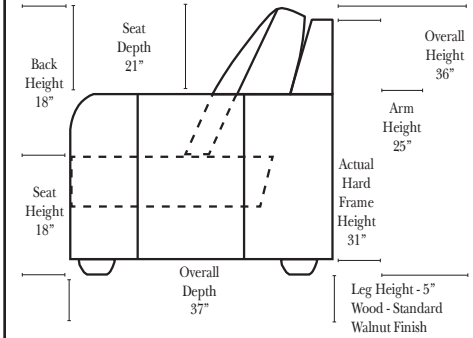
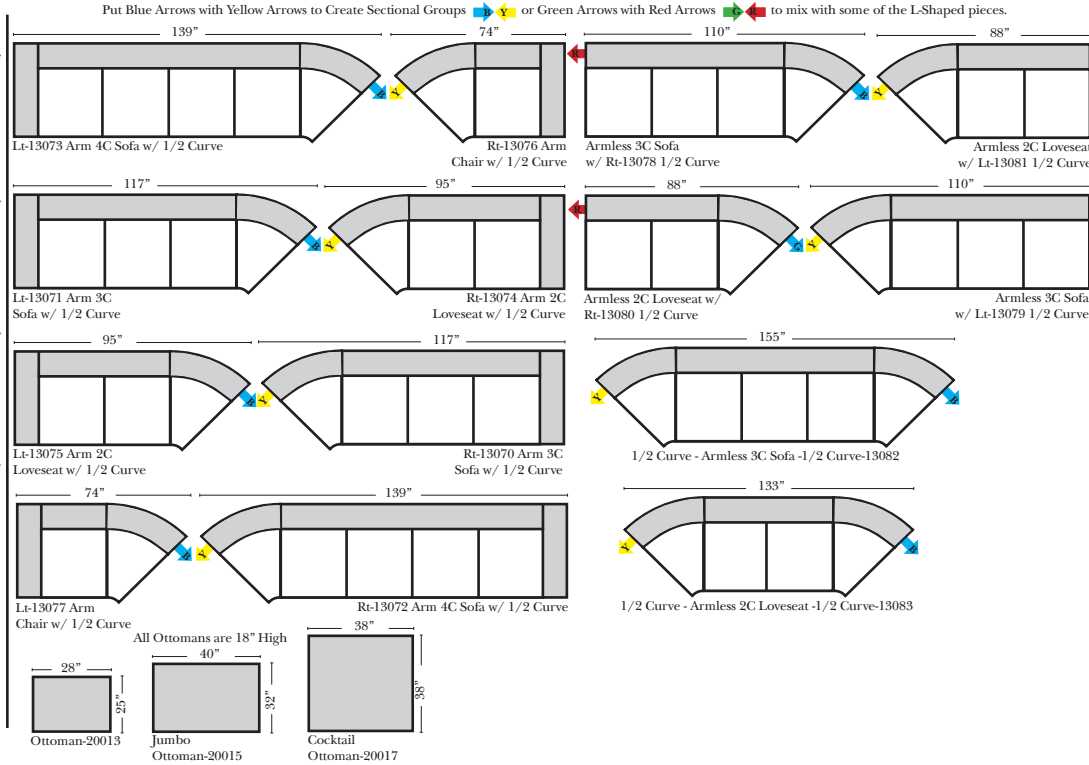
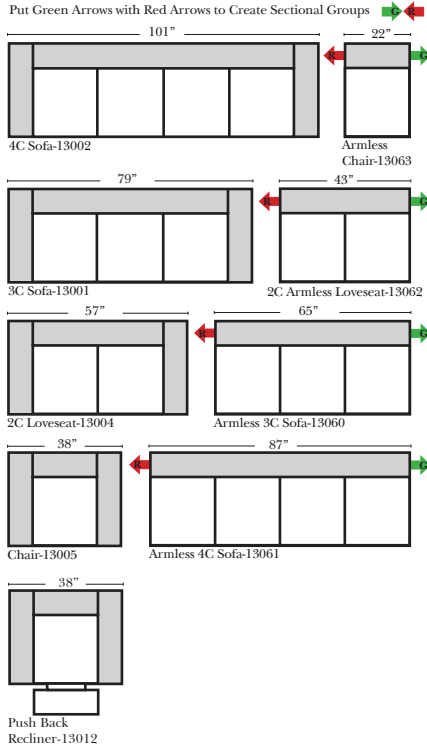

Standard & options

Standard:

- Available in Full & Top Grain Leathers
- Available in Luxury Fabrics
- All Hardwood Frames
- Nail Heads - Pewter
- Welting
- Wood Leg Finish (Standard is Walnut)

Options: (No Additional Charge)

- No. 33 Firm Foam Cushions
- Wood Leg Finish(Available in Cherry, Chocolate, Espresso, Honey Oak, & Shadow)

Options: (additional Charge)

- Down Seats & Down Backs
- Upholstered Swivel Base(2 arm Chair Only)

Sleeper Options: (No Sleeper available on this style)

L-Shape / 90 Degree Sectional

(All 4 seat items ship as one piece)

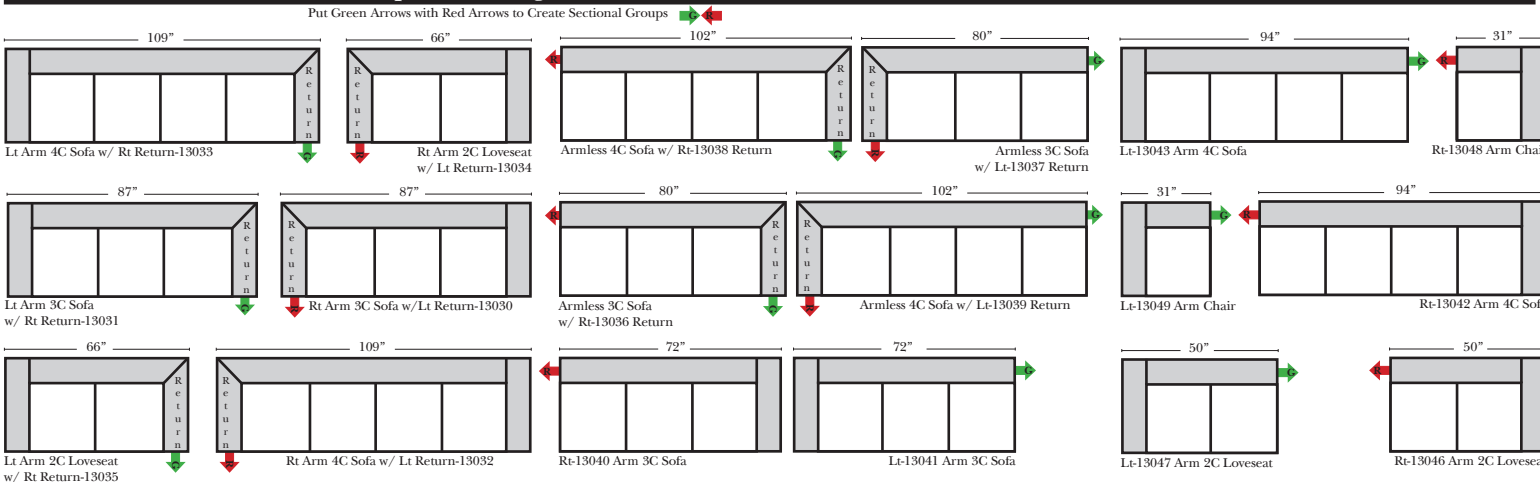

Note:

All Dimensions are approximate, if accuracy is crucial, please contact us for validation of the dimensions shown. However, a 1" to 2" variance can still apply due to foam and upholstery.

Bumper / Return Chaise & Conversation Sofas

Put Green Arrows with Red Arrows to Create Sectional Groups
Put Orange Arrows with Tan Arrows to Create Sectional Groups

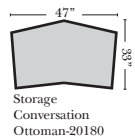
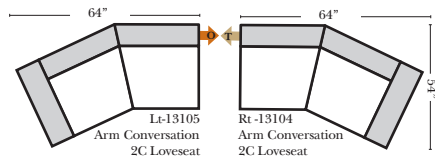
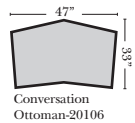
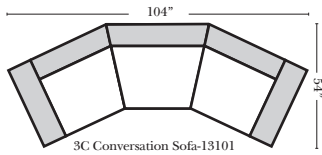
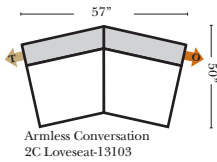
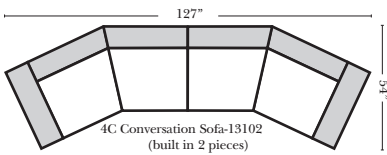
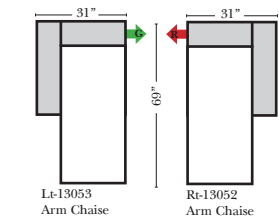

Sleepers

Put Green Arrows with Red Arrows to Create Sectional Groups
Put Blue Arrows with Yellow Arrows to Create Sectional Groups

No Sleepers available
on this style

Suggested Configurations

v.12.02.13

The Suggested Configurations below are only a sample of what the imagination can create, please enjoy creating the configuration that fits your lifestyle, using the ideas below and from the items on the opposite page.

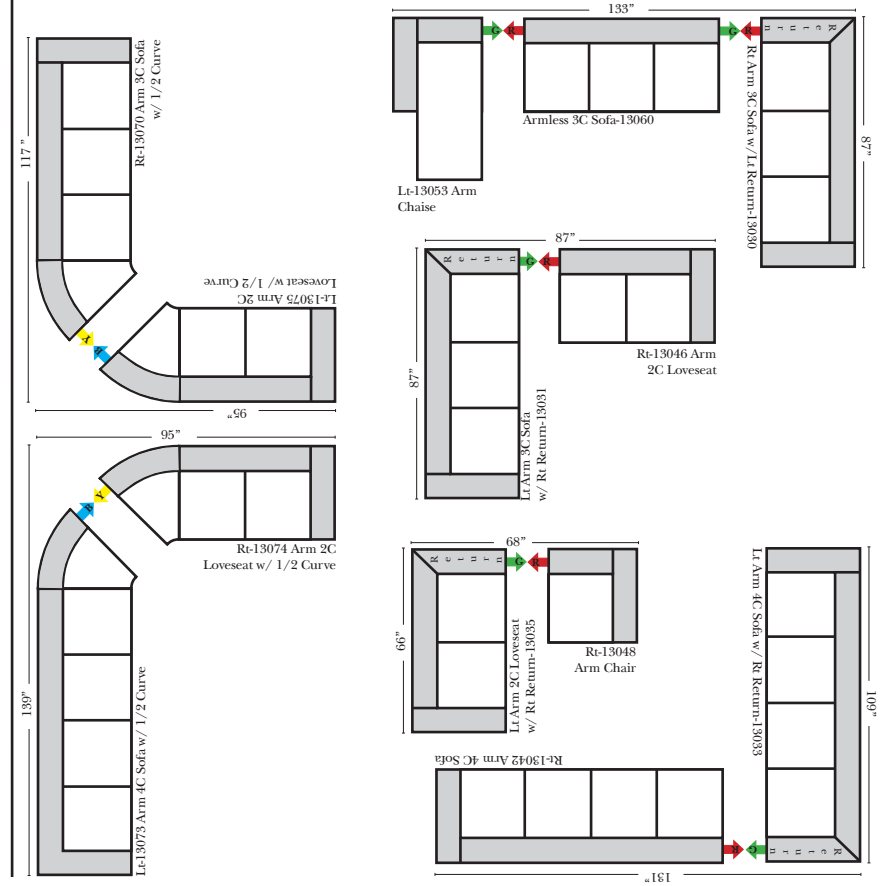

Sleepers (Cont.)