

## Standard / Ottomans / Armless

## 2-Piece Curve Sectional

v.10.25.17

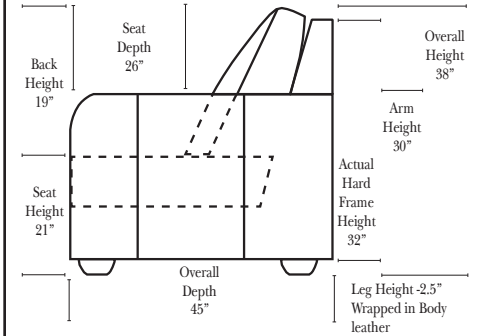
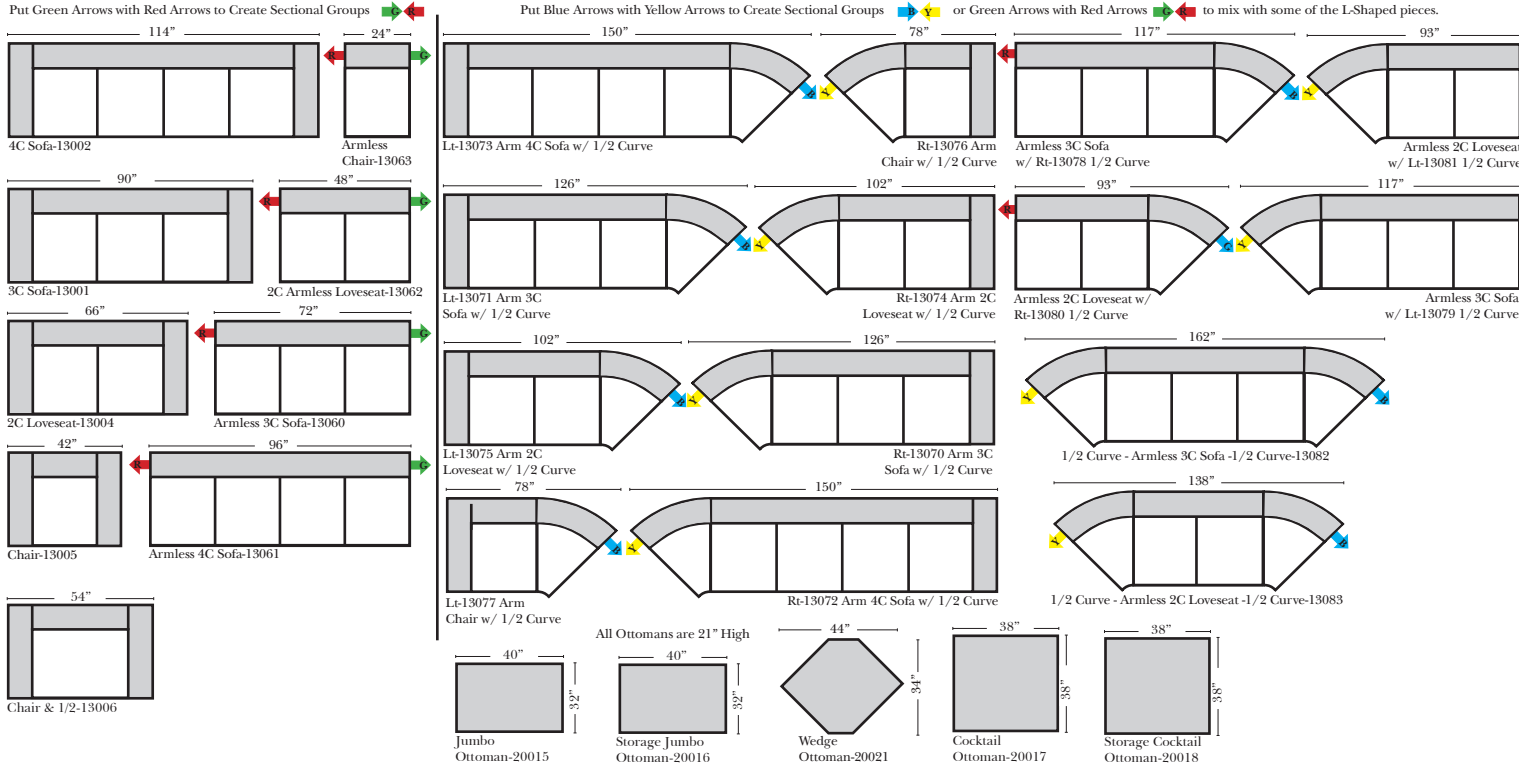

### Standard & Options

#### Standard:

- Available in Full & Top Grain Leathers
- All Hardwood Frames
- Wood Leg Wrapped with Body Leather

#### Options: (No Additional Charge)

- No. 33 Firm Foam

#### Options: (Additional Charges Apply)

- Down Seats

#### Sleeper Options: (Additional Charges Apply)

- Queen Sleeper available w/Standard Mattress
- Twin Sleeper available w/Standard Mattress
- Deluxe Innerspring Mattress: Queen / Twin
- Air Dream Coil Mattress: Queen Only - (No Twin)
- Hideaway Air Mattress: Queen Only (Shipped in a Separate Box)

## L-Shape / 90 Degree Sectional

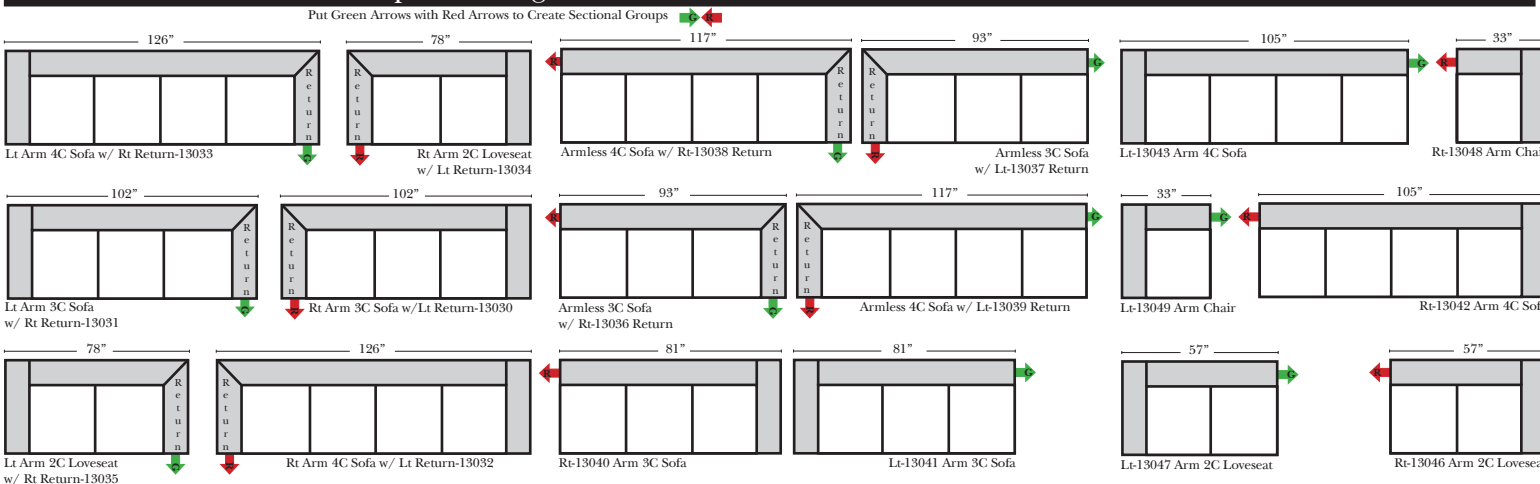

(All 4 seat items ship as one piece if stationary, two pieces if motion installed)



#### Note:



All Dimensions are approximate, if accuracy is crucial, please contact us for validation of the dimensions shown. However, a 1" to 2" variance can still apply due to foam and upholstery.

## Bumper / Return Chaise & Conversation Sofas

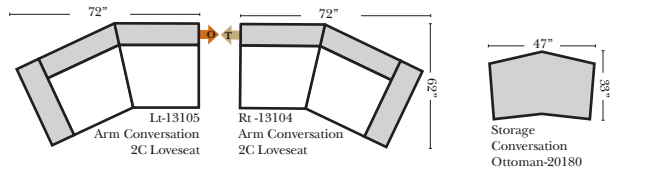
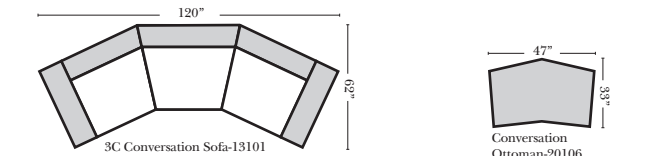
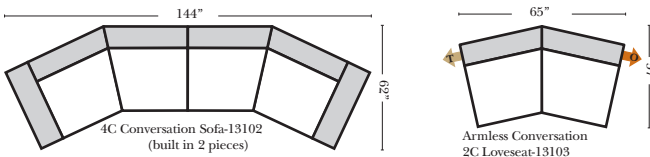
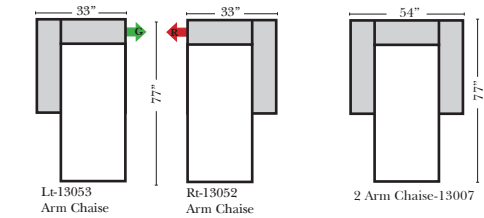
Put Green Arrows with Red Arrows to Create Sectional Groups   
Put Orange Arrows with Tan Arrows to Create Sectional Groups 



## Sleepers

Put Green Arrows with Red Arrows to Create Sectional Groups   
Put Blue Arrows with Yellow Arrows to Create Sectional Groups 

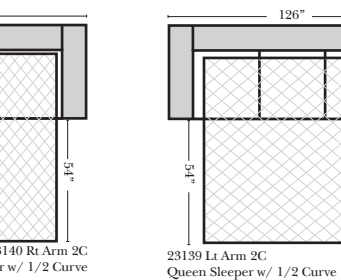
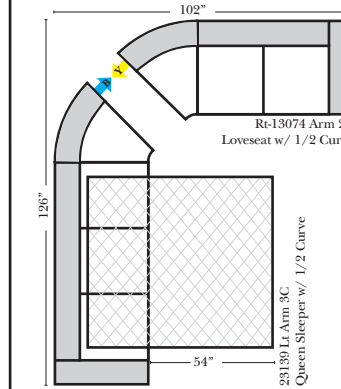
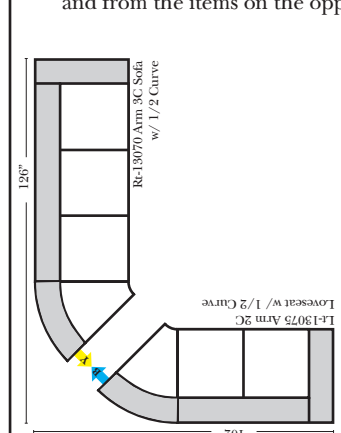
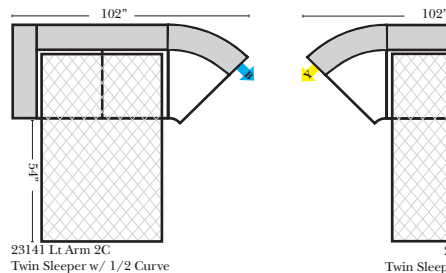
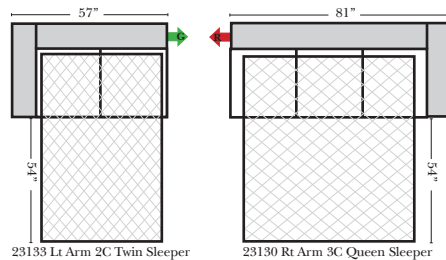
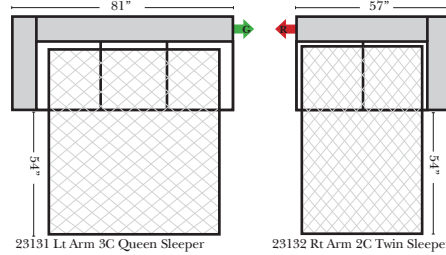
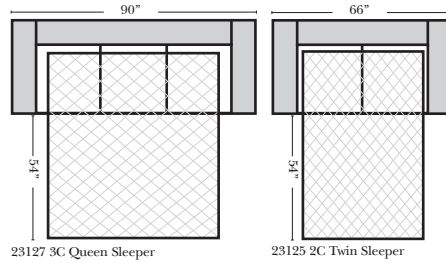

## Sleepers (Cont.)

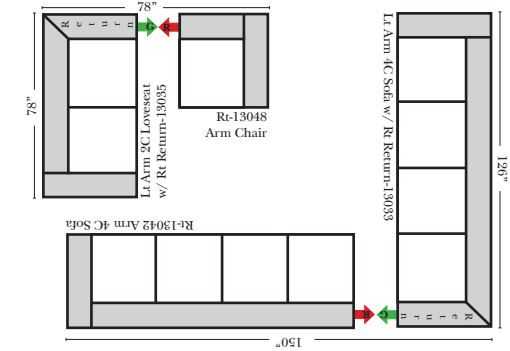
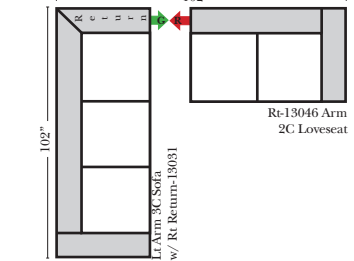
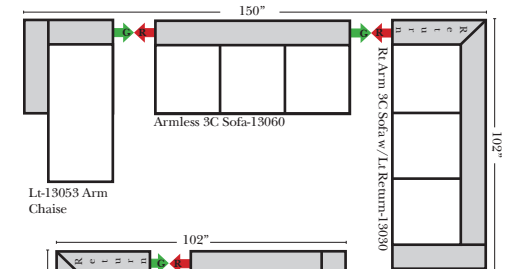

## Suggested Configurations

v.10.25.17

The Suggested Configurations below are only a sample of what the imagination can create, please enjoy creating the configuration that fits your lifestyle, using the ideas below and from the items on the opposite page.