

## Standard, Armless & Ottomans (All 4 seat items ship as one piece if stationary, two pieces if motion installed)

## 2 Piece Curve Sectional & Ottomans

v.03.07.18

Put Green Arrows with Red Arrows to Create Sectional Groups

Put Blue Arrows with Yellow Arrows to Create Sectional Groups or Green Arrows with Red Arrows to mix with some of the L-Shaped pieces.

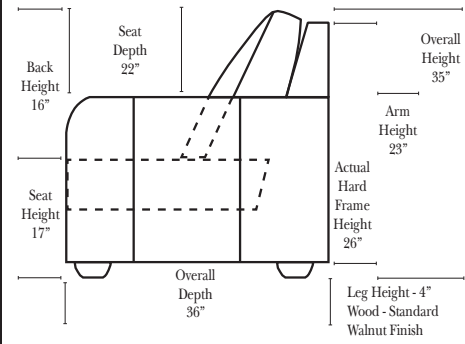
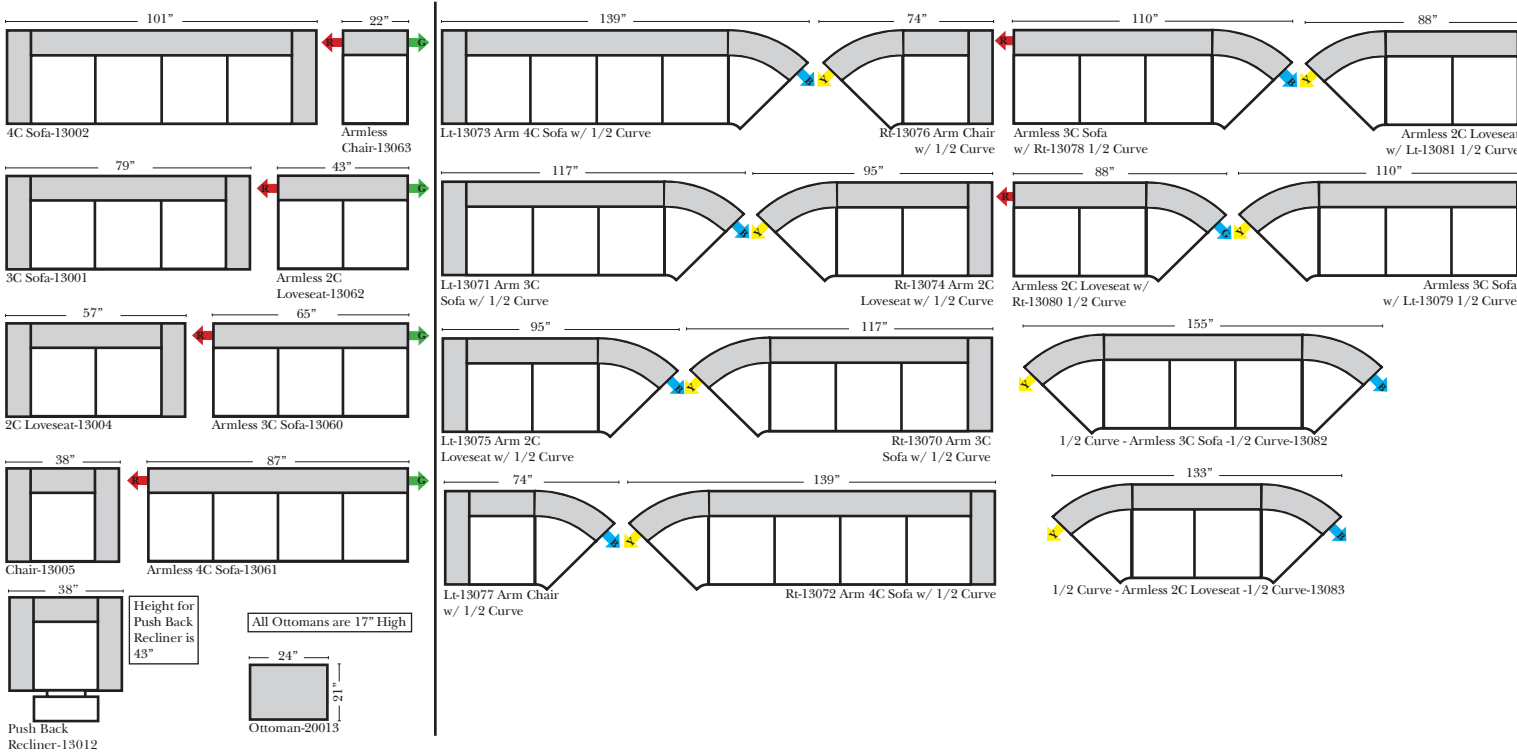

### Specifications & Options

- Standard:**
- Available in Full & Top Grain Leathers
  - Available in Luxury Fabrics
  - All Hardwood Frames
  - Leg Color - Walnut
- Options Available with No Additional Charge:**
- Change Leg Color to: Cherry, Chocolate, Espresso, Honey Oak, & Shadow
  - No. 33 Firm Foam
  - Contrast Stitching (Natural Color Only)

- Options that have Additional Charges:**
- Add Down Seats & Backs

**Sleeper Options :** (Sleepers not available at this time)  
N/A



**Note:**  
All Dimensions are approximate, if accuracy is crucial, please contact us for validation of the dimensions shown. However, a 1" to 2" variance can still apply due to foam and upholstery.

## L-Shape / 90 Degree Sectional

(All 4 seat items ship as one piece if stationary, two pieces if motion installed)

Put Green Arrows with Red Arrows to Create Sectional Groups

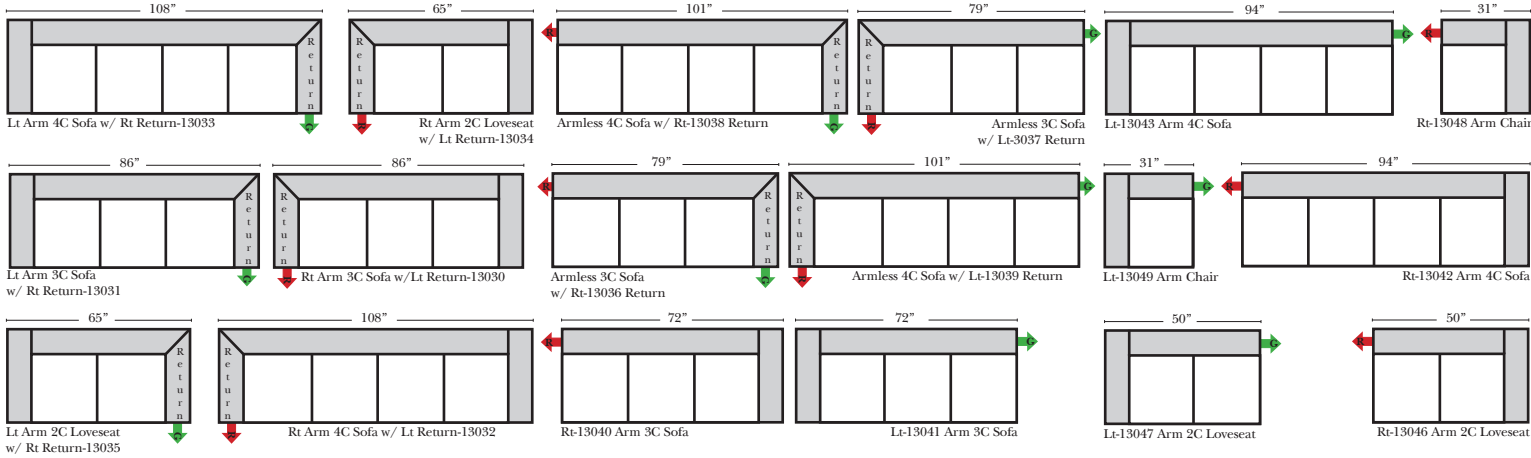

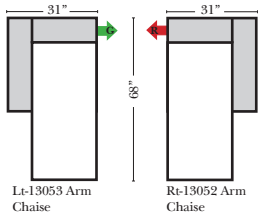

**Chaise & Conversation Sectionals**

Put Green Arrows with Red Arrows to Create Sectional Groups 



Conversation Sectionals  
for this style not available  
at this time

**Sleepers**

Put Green Arrows with Red Arrows to Create Sectional Groups   
Put Blue Arrows with Yellow Arrows to Create Sectional Groups 

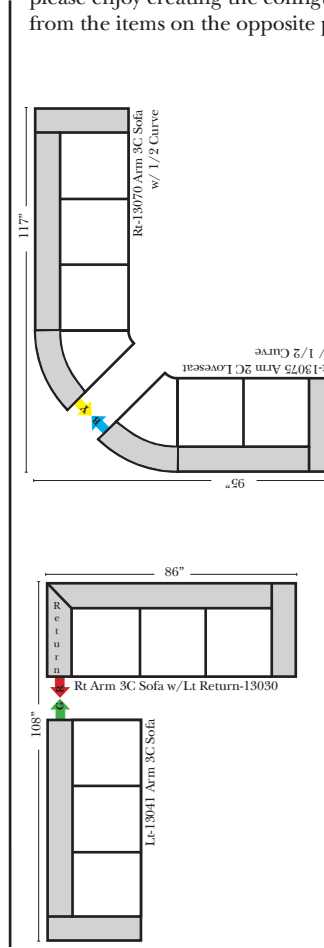

Sleepers  
for this style not available  
at this time

**Suggested Configurations**

v.03.07.18

The Suggested Configurations below are only a sample of what the imagination can create, please enjoy creating the configuration that fits your lifestyle, using the ideas below and from the items on the opposite page.

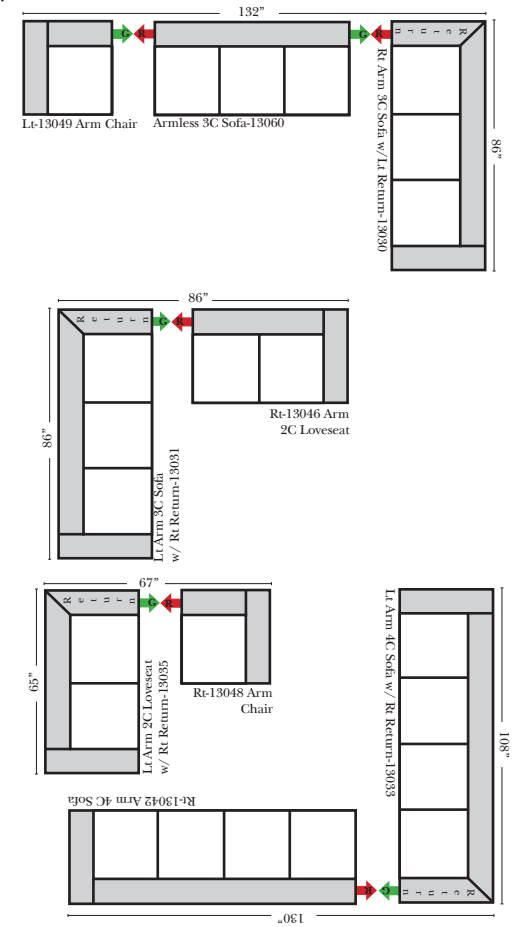

**Sleepers (Cont.)**