

Standard & Ottomans

Armless

Put Green Arrows with Red Arrows to Create Sectional Groups → ←

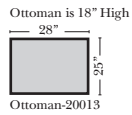
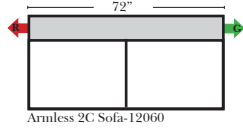
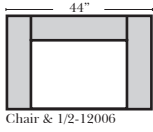
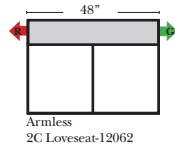
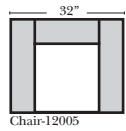
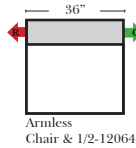
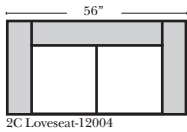
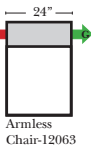
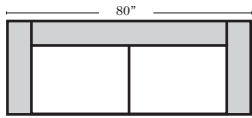

Suggested Configurations

v.04.24.16

The Suggested Configurations below are only a sample of what the imagination can create, please enjoy creating the configuration that fits your lifestyle, using the ideas below.

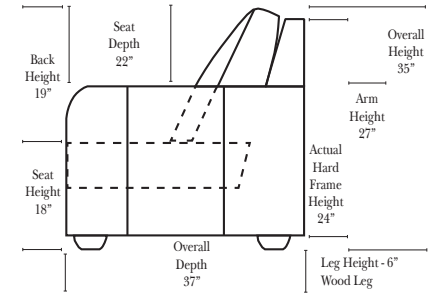
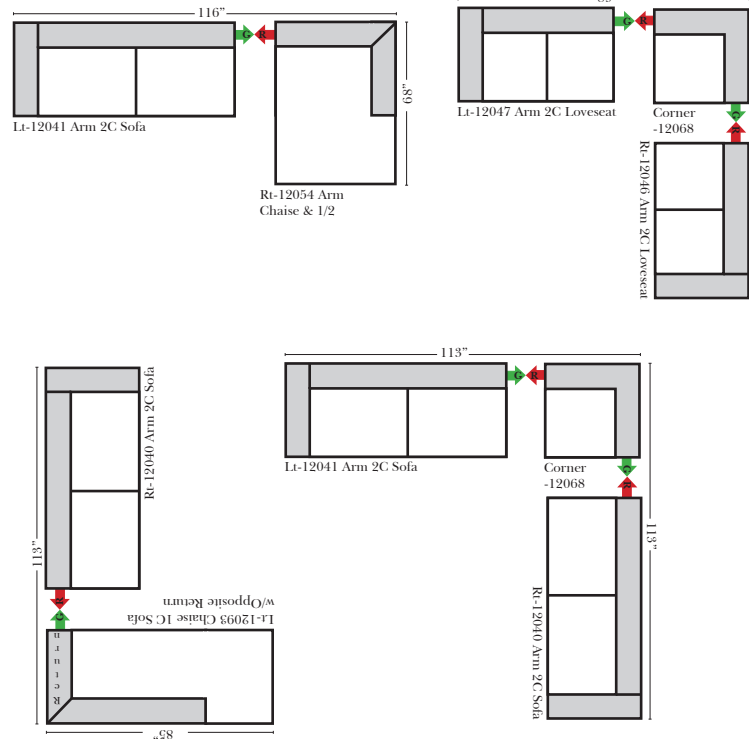

Feature & Options

Standard:

- Available in Full & Top Grain Leathers
- Available in Luxury Fabrics
- All Hardwood Frames
- Wood Leg Finish - Standard: Walnut

Options Available with No Additional Charge:

- No. 33 Firm Foam
- Wood Leg - Finishes - Cherry, Chocolate, Espresso, Honey oak, Shadow, Walnut

Options that have Additional Charges:

- Down Seats & Backs (additional Charge)

Sleeper Options: (N/A on this style)

90 Degree / L-Shape Sectional / Chaise

Put Green Arrows with Red Arrows to Create Sectional Groups → ←

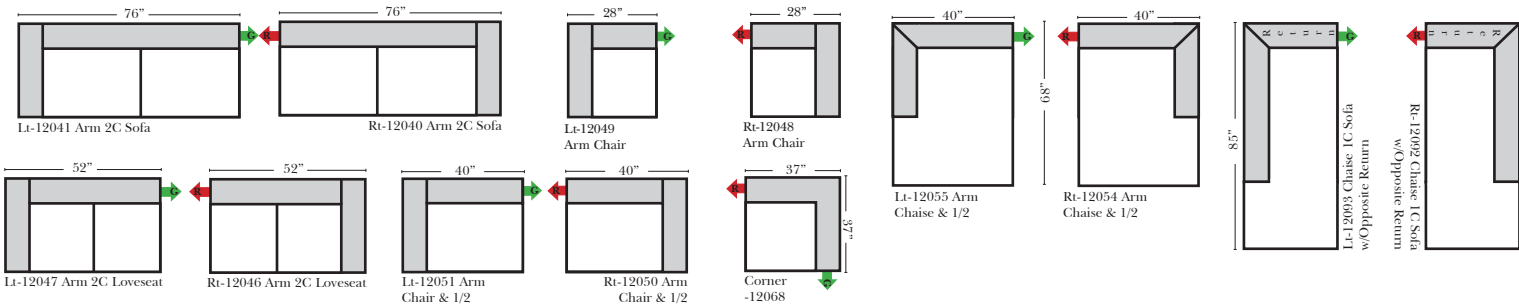

Note:

All Dimensions are approximate, if accuracy is crucial, please contact us for validation of the dimensions shown. However, a 1" to 2" variance can still apply due to foam and upholstery.