

## Standard / Ottomans / Armless

## 2-Piece Curve Sectional

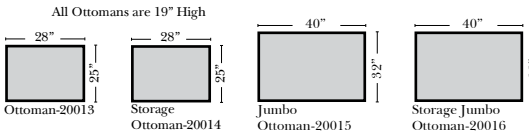
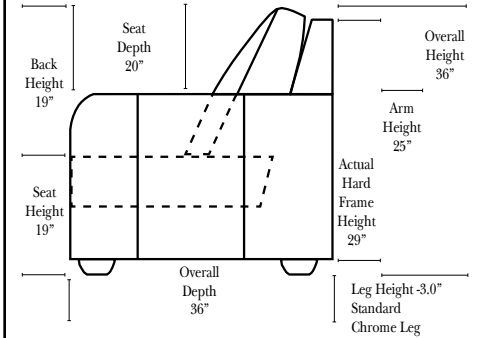
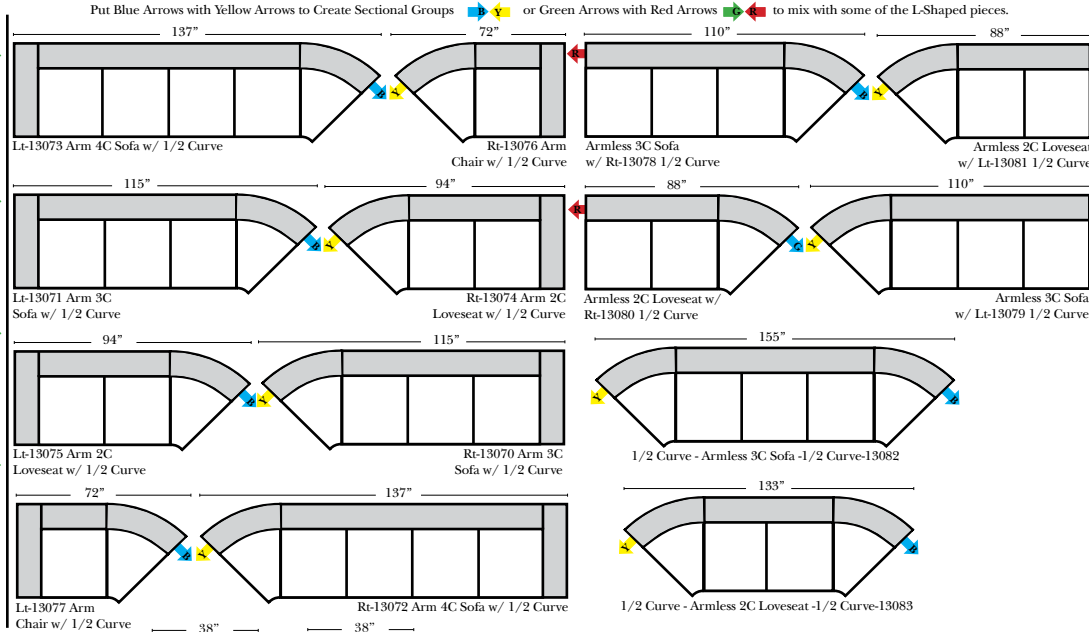
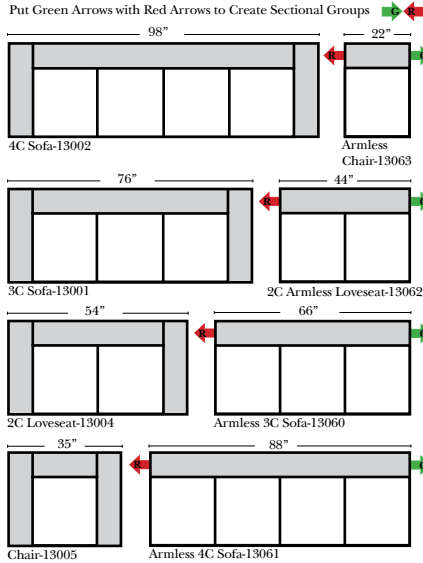

### Standard & Options

#### Standard:

- Available in Full & Top Grain Leathers
- Available in Luxury Fabrics
- All Hardwood Frames
- Chrome Leg

#### Options: (No Additional Charge)

- No. 33 Firm Foam
- Wood Leg Finish (Available in Cherry, Chocolate, Espresso, Honey Oak, & Shadow)
- Arm Pillows (will be included, ONLY when a style is ordered with fabric seat AND back cushions)

#### Options: (Additional Charges Apply)

- Down Seats & Down Backs
- Upholstered Swivel Base(2 arm Chair Only)

#### Sleeper Options: (Additional Charges Apply)

- Full Sleeper available w/Standard Mattress
- 5" Memory Foam Mattress: Full
- Air Dream Coil Mattress: Full Only

## L-Shape / 90 Degree Sectional

(All 4 seat items ship as one piece if stationary, two pieces if motion installed)

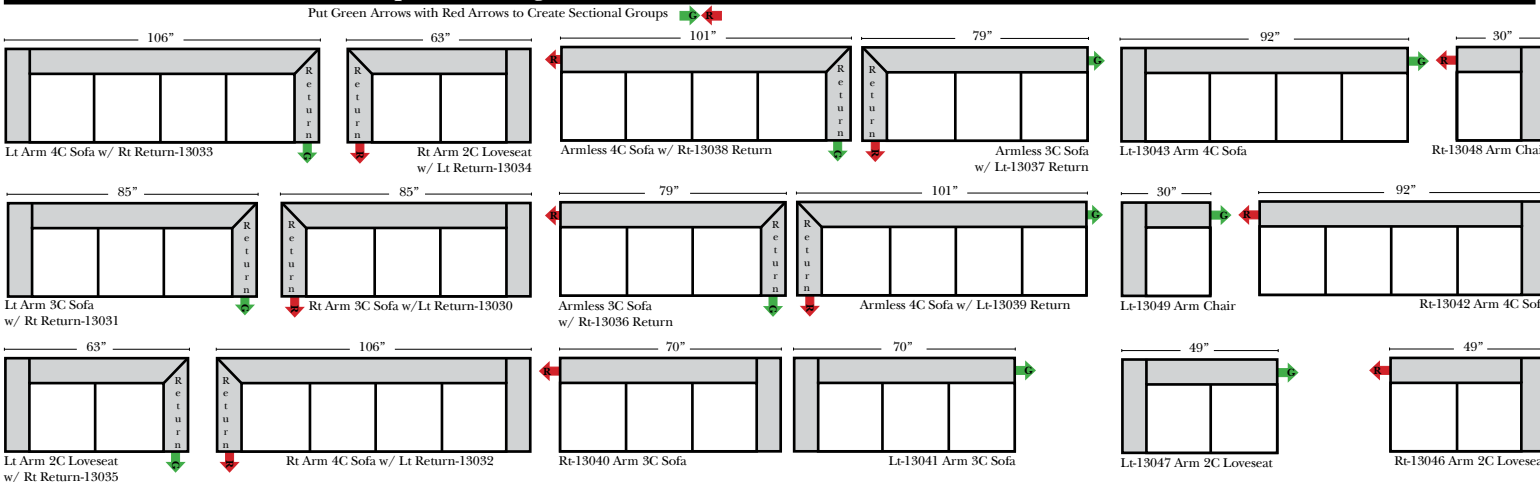

#### Note:

All Dimensions are approximate, if accuracy is crucial, please contact us for validation of the dimensions shown. However, a 1" to 2" variance can still apply due to foam and upholstery.

## Bumper / Return Chaise & Conversation Sofas

Put Green Arrows with Red Arrows to Create Sectional Groups  
Put Orange Arrows with Tan Arrows to Create Sectional Groups

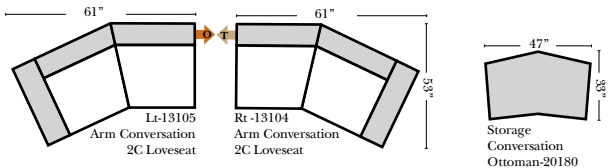
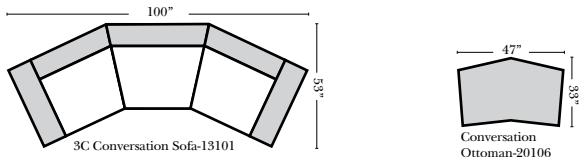
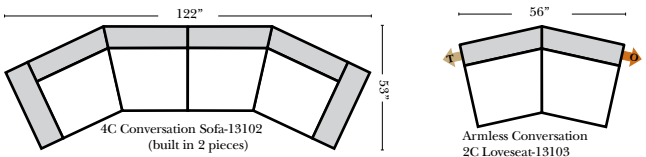
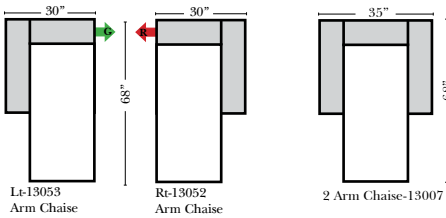
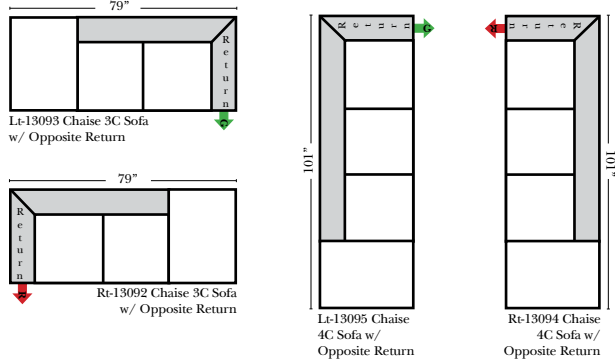

## Sleepers

Put Green Arrows with Red Arrows to Create Sectional Groups  
Put Blue Arrows with Yellow Arrows to Create Sectional Groups

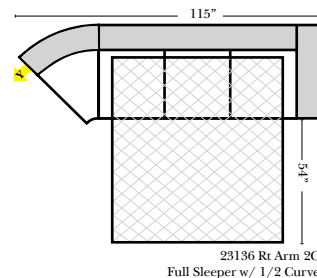
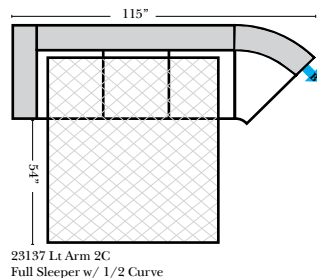
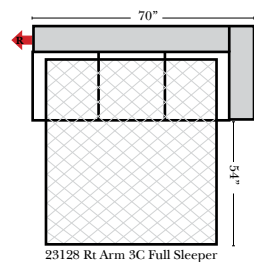
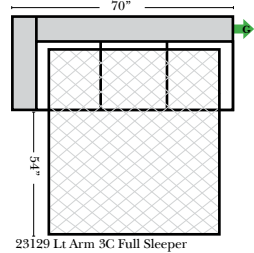
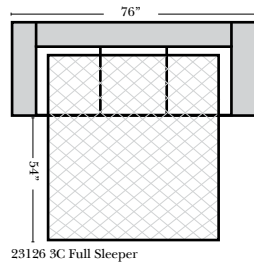

## Suggested Configurations

v.05.10.18

The Suggested Configurations below are only a sample of what the imagination can create, please enjoy creating the configuration that fits your lifestyle, using the ideas below and from the items on the opposite page.

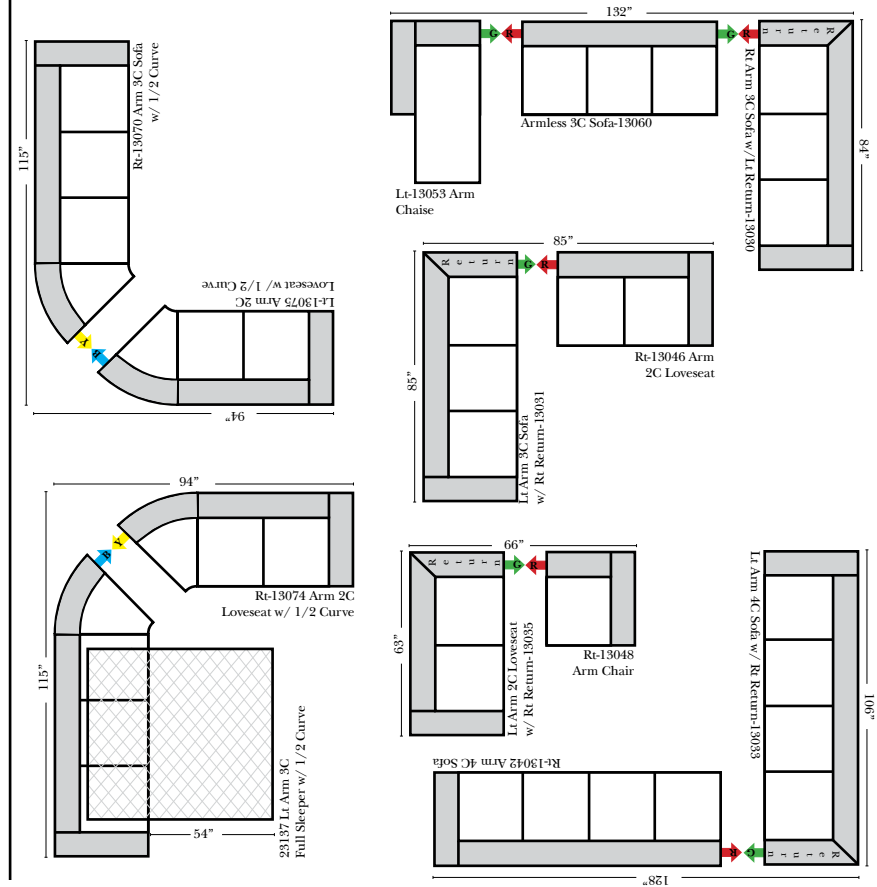

## Sleepers (Cont.)

**Standard / Ottomans / Armless**

**2-Piece Curve Sectional**

v.05.10.18

Put Green Arrows with Red Arrows to Create Sectional Groups

Put Blue Arrows with Yellow Arrows to Create Sectional Groups or Green Arrows with Red Arrows to mix with some of the L-Shaped pieces.

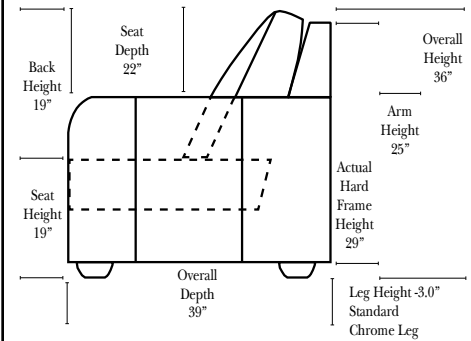
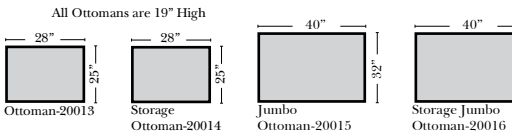
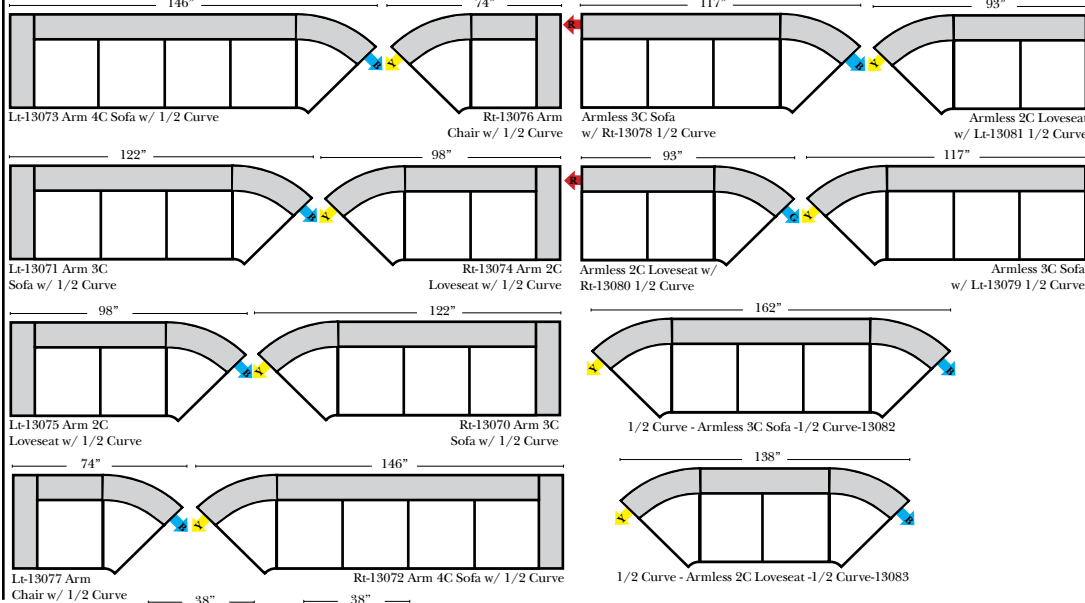
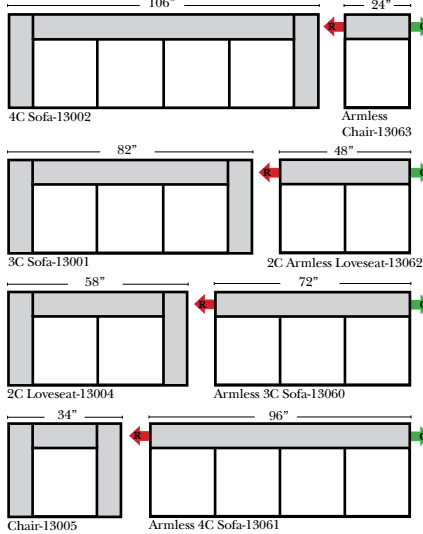

**Standard & Options**

**Standard:**

- Available in Full & Top Grain Leathers
- Available in Luxury Fabrics
- All Hardwood Frames
- Chrome Leg

**Options: (No Additional Charge)**

- No. 33 Firm Foam
- Wood Leg Finish (Available in Cherry, Chocolate, Espresso, Honey Oak, & Shadow)
- Arm Pillows (will be included, ONLY when a style is ordered with fabric seat AND back cushions)

**Options: (Additional Charges Apply)**

- Down Seats & Down Backs
- Upholstered Swivel Base(2 arm Chair Only)

**Sleeper Options: (Additional Charges Apply)**

- Queen Sleeper available w/Standard Mattress
- Twin Sleeper available w/Standard Mattress
- 5" Memory Foam Mattress: Queen / Twin
- Air Dream Coil Mattress: Queen Only - (No Twin)
- Hideaway Air Mattress: Queen Only (Shipped in a Separate Box)

**L-Shape / 90 Degree Sectional**

(All 4 seat items ship as one piece if stationary, two pieces if motion installed)

Put Green Arrows with Red Arrows to Create Sectional Groups

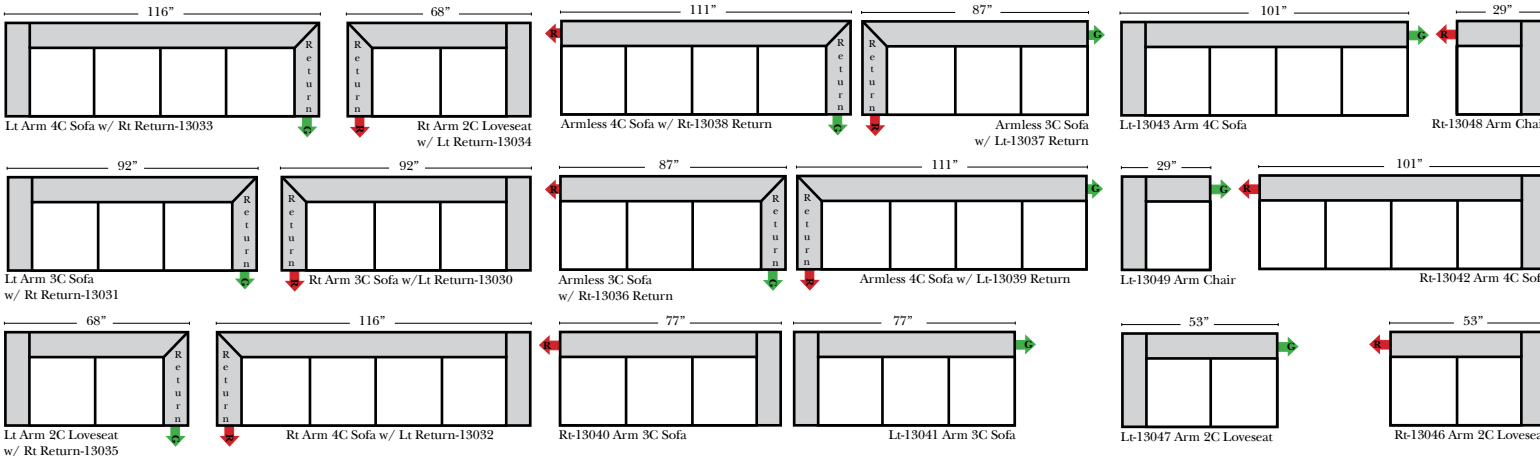

**Note:**

All Dimensions are approximate, if accuracy is crucial, please contact us for validation of the dimensions shown. However, a 1" to 2" variance can still apply due to foam and upholstery.

## Bumper / Return Chaise & Conversation Sofas

Put Green Arrows with Red Arrows to Create Sectional Groups  
Put Orange Arrows with Tan Arrows to Create Sectional Groups

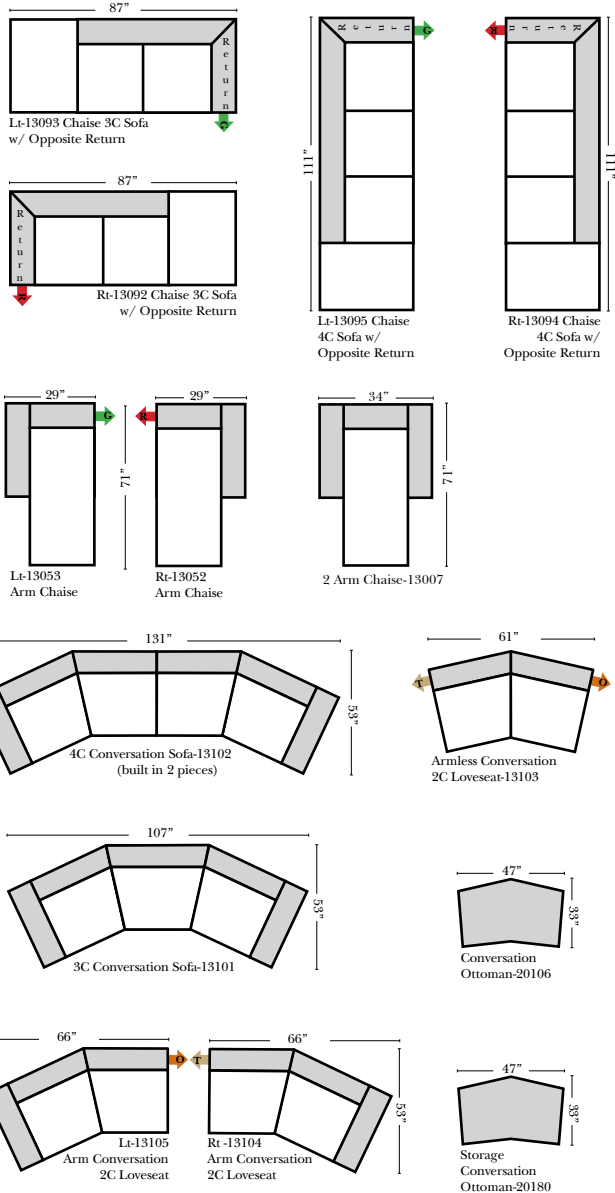

## Sleepers

Put Green Arrows with Red Arrows to Create Sectional Groups  
Put Blue Arrows with Yellow Arrows to Create Sectional Groups

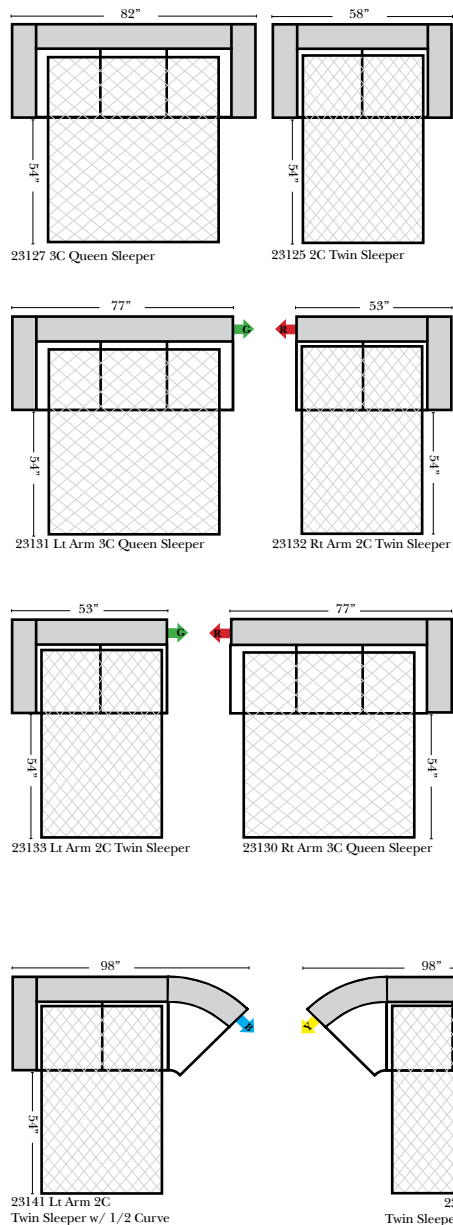

## Suggested Configurations

v.05.10.18

The Suggested Configurations below are only a sample of what the imagination can create, please enjoy creating the configuration that fits your lifestyle, using the ideas below and from the items on the opposite page.

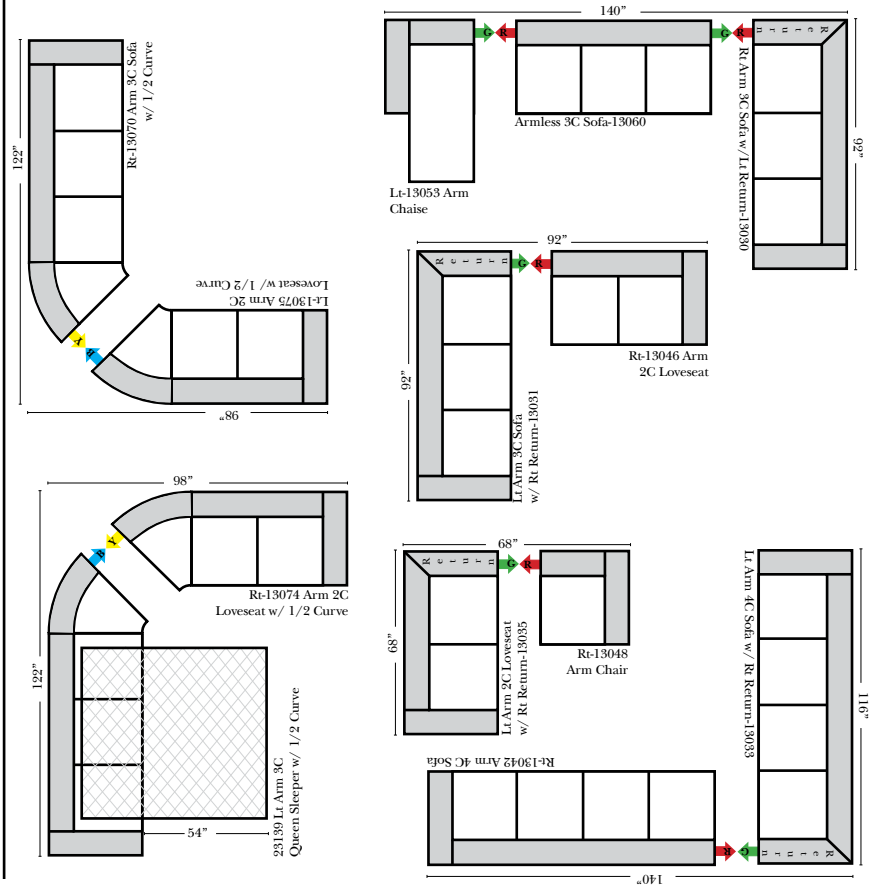

## Sleepers (Cont.)

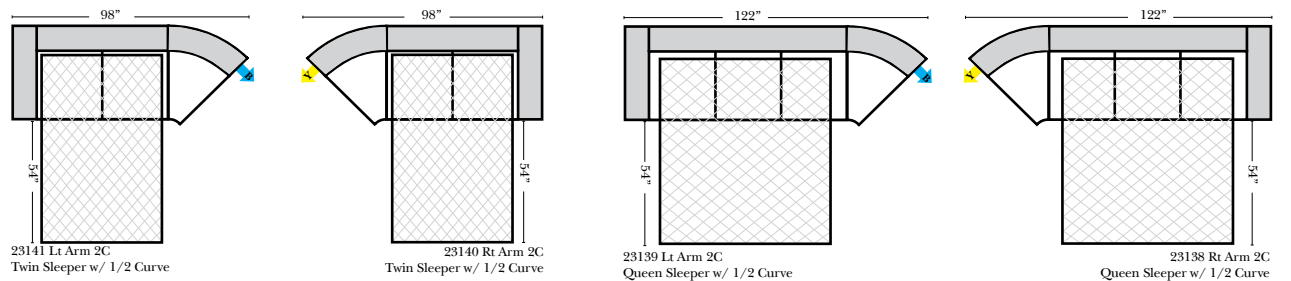

## Standard / Ottomans / Armless

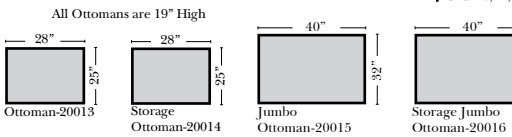
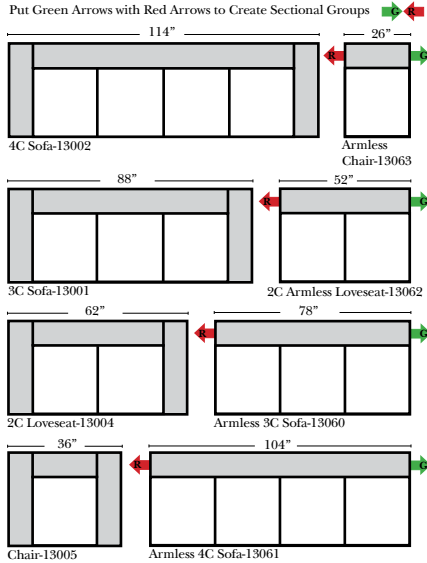

## 2-Piece Curve Sectional

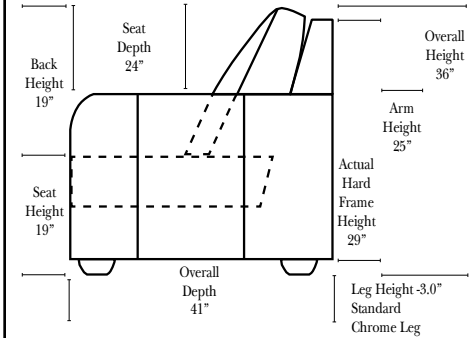
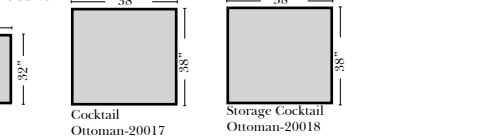
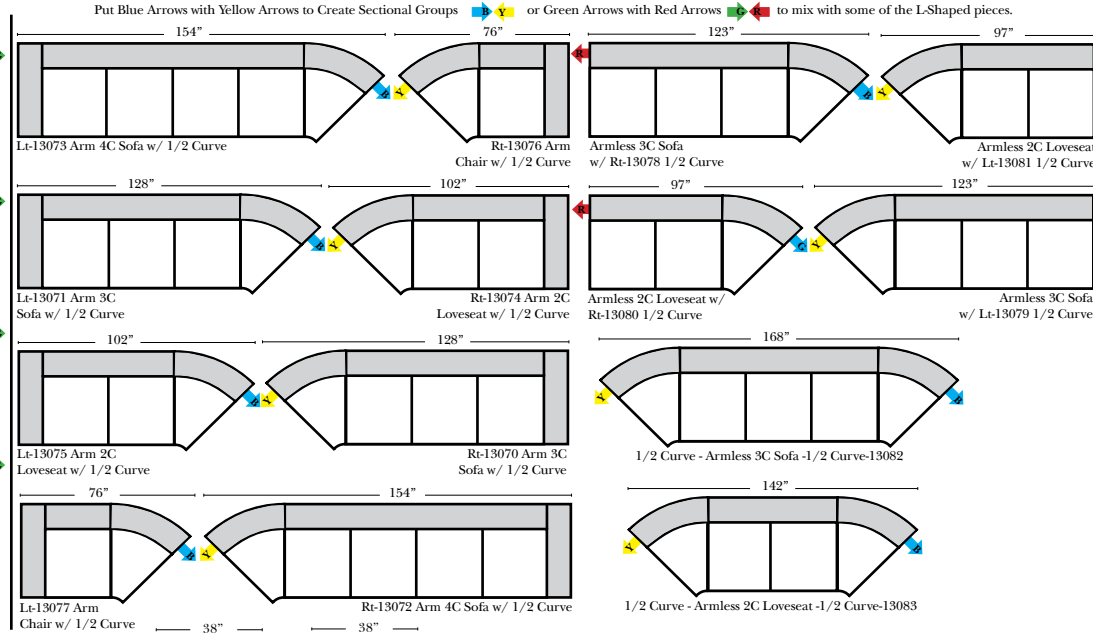

### Standard & Options

#### Standard:

- Available in Full & Top Grain Leathers
- Available in Luxury Fabrics
- All Hardwood Frames
- Chrome Leg

#### Options: (No Additional Charge)

- No. 33 Firm Foam
- Wood Leg Finish (Available in Cherry, Chocolate, Espresso, Honey Oak, & Shadow)
- Arm Pillows (will be included, ONLY when a style is ordered with fabric seat AND back cushions)

#### Options: (Additional Charges Apply)

- Down Seats & Down Backs
- Upholstered Swivel Base(2 arm Chair Only)

#### Sleeper Options: (Additional Charges Apply)

- Queen Sleeper available w/Standard Mattress
- Twin Sleeper available w/Standard Mattress
- 5" Memory Foam Mattress: Queen / Twin
- Air Dream Coil Mattress: Queen Only - (No Twin)
- Hideaway Air Mattress: Queen Only (Shipped in a Separate Box)

## L-Shape / 90 Degree Sectional

(All 4 seat items ship as one piece if stationary, two pieces if motion installed)

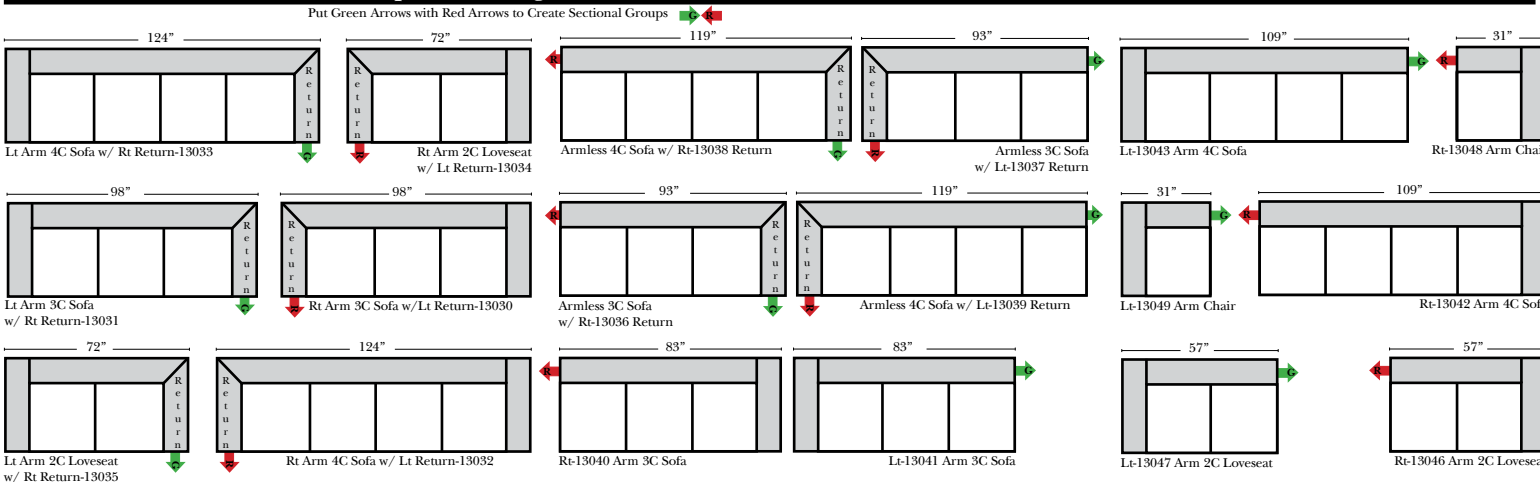

#### Note:

All Dimensions are approximate, if accuracy is crucial, please contact us for validation of the dimensions shown. However, a 1" to 2" variance can still apply due to foam and upholstery.



## Bumper / Return Chaise & Conversation Sofas

Put Green Arrows with Red Arrows to Create Sectional Groups  
Put Orange Arrows with Tan Arrows to Create Sectional Groups

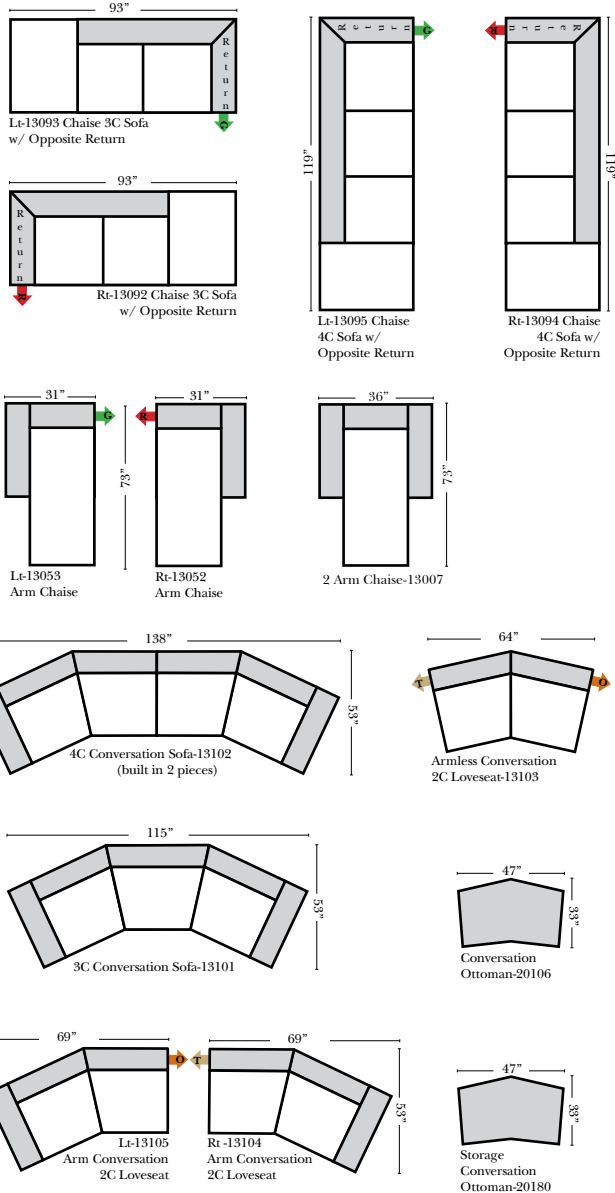

## Sleepers

Put Green Arrows with Red Arrows to Create Sectional Groups  
Put Blue Arrows with Yellow Arrows to Create Sectional Groups

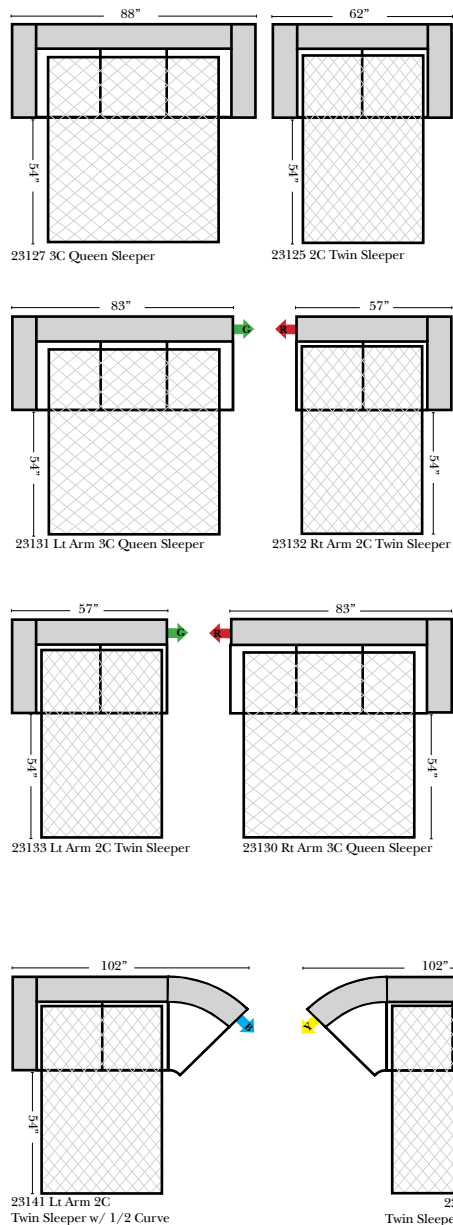

## Suggested Configurations

v.05.10.18

The Suggested Configurations below are only a sample of what the imagination can create, please enjoy creating the configuration that fits your lifestyle, using the ideas below and from the items on the opposite page.

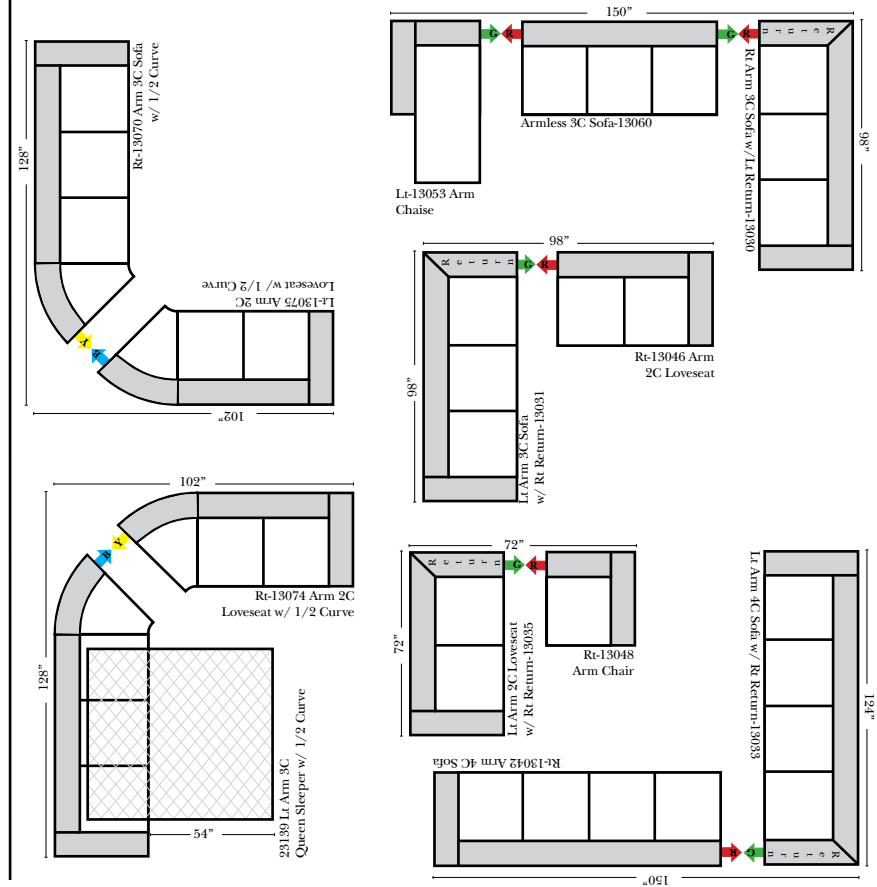

## Sleepers (Cont.)

