

Santa Barbara

Standard

Curve Sectional Pieces

2-Piece Curve Sectional

Put Green Arrows with Red Arrows to Create Sectional Groups

Put Blue Arrows with Yellow Arrows to Create Sectional Groups

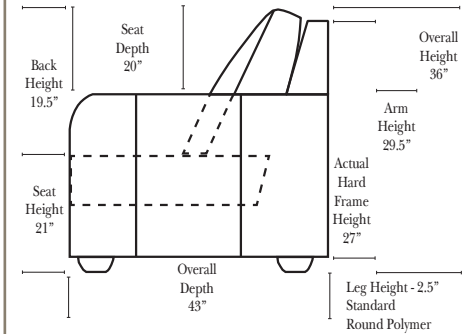
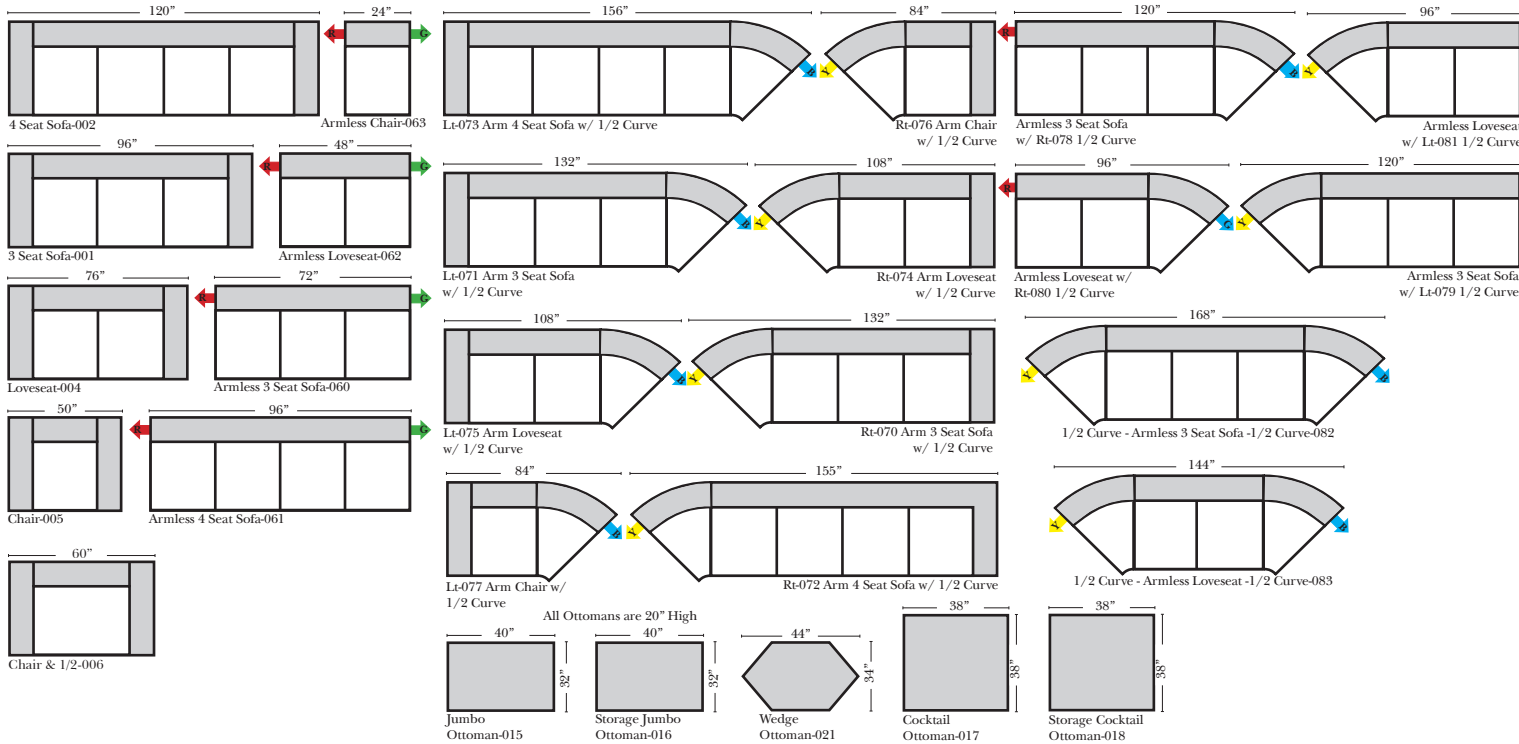

Specifications & Options

Standard:

- Available in Full & Top Grain Leathers
- All Hardwood Frames
- Leg Color - Black Polymer Leg

Options Available with No Additional Charge:

- No. 33 Firm Foam

Options that have Additional Charges:

- Add Down Seats
- Add Storage to Ottoman
- Add Upholstered Swivel Base (2 Arm Chair Only)

Sleeper Options : N/A on this style



L-Shape / 90 Degree Sectional

Put Green Arrows with Red Arrows to Create Sectional Groups

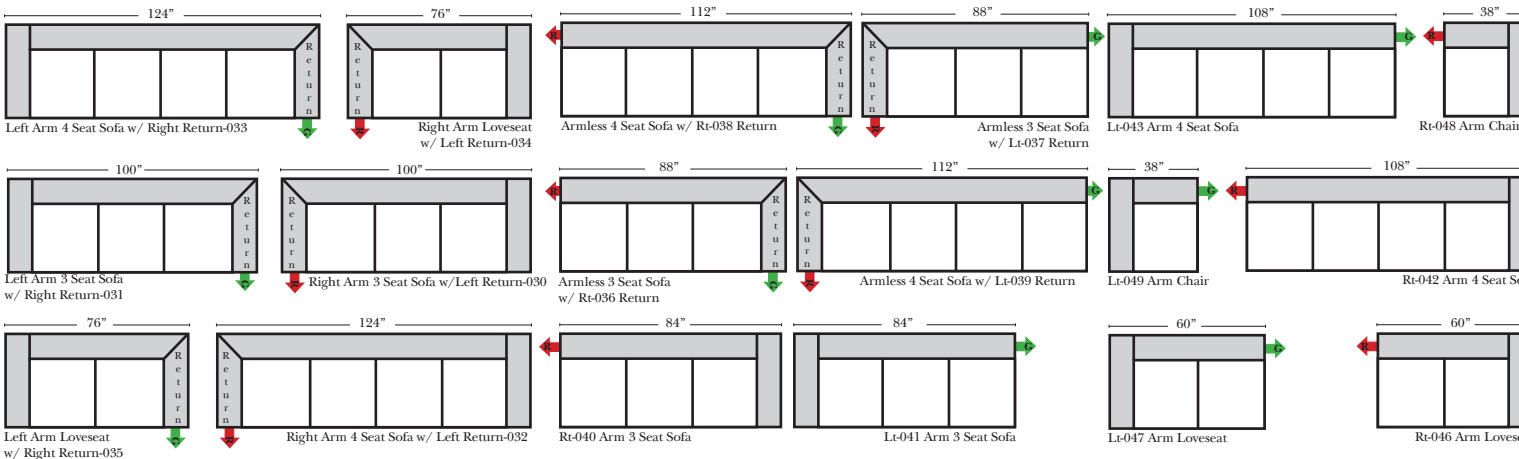



Note:



All Dimensions are approximate, if accuracy is crucial, please contact us for validation of the dimensions shown. However, a 1\"/>

Santa Barbara

Chaise / Conversation Sofas Sectional Pieces

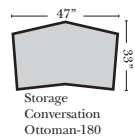
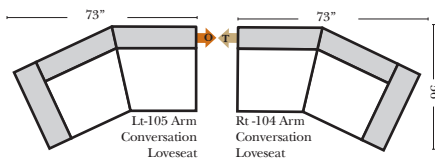
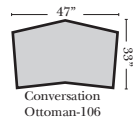
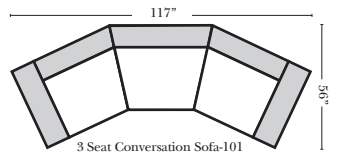
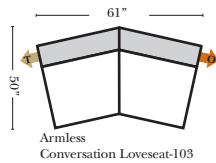
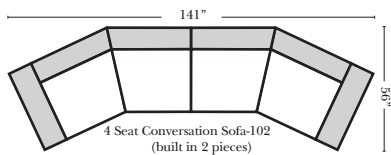
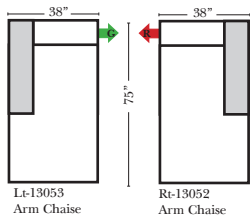
Put Green Arrows with Red Arrows to Create Sectional Groups 
Put Orange Arrows with Tan Arrows to Create Sectional Groups 



Put Green Arrows with Red Arrows to Create Sectional Groups 
Put Blue Arrows with Yellow Arrows to Create Sectional Groups 

Sleepers
for this style not available
at this time

Suggested Configurations

The Suggested Configurations below are only a sample of what the imagination can create, please enjoy creating the configuration that fits your lifestyle, using the ideas below and from the items on the opposite page.

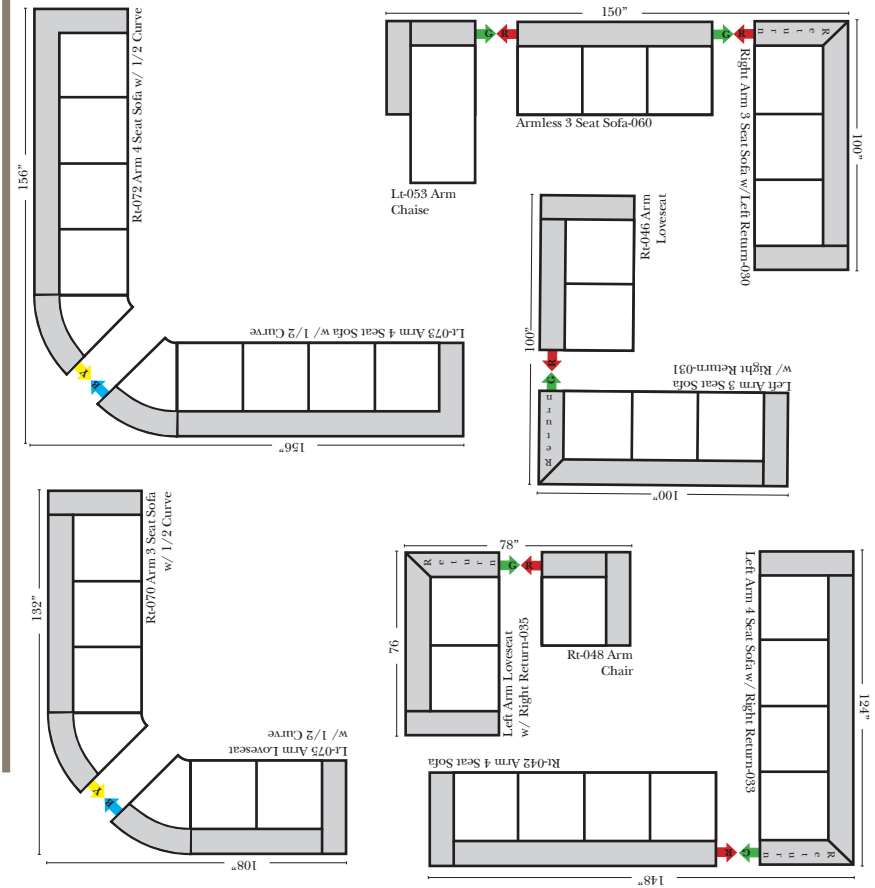

Suggested Configurations (Cont.)

Sleepers
for this style not available
at this time