

Standard / Ottomans

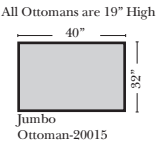

Conversation Sofas / Ottomans

Put Orange Arrows with Tan Arrows to Create Sectional Groups

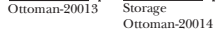
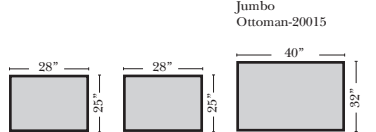
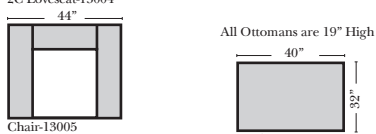
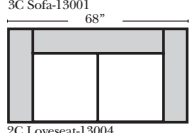
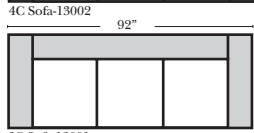
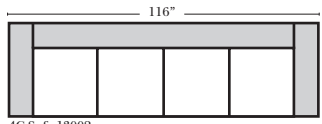
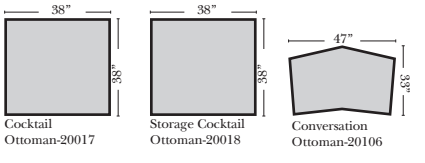
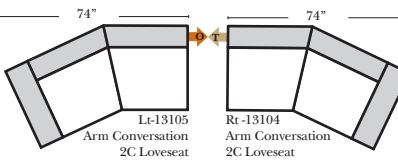
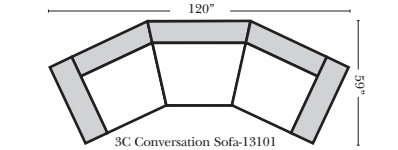
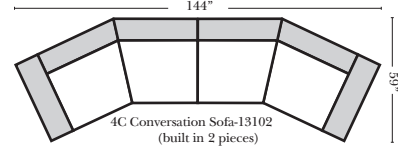

Suggested Configurations

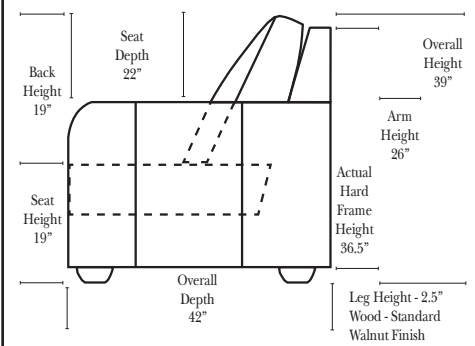
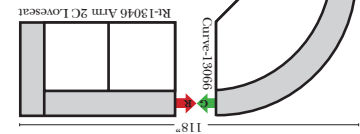
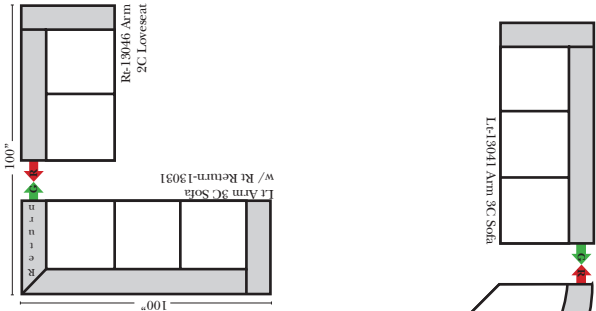
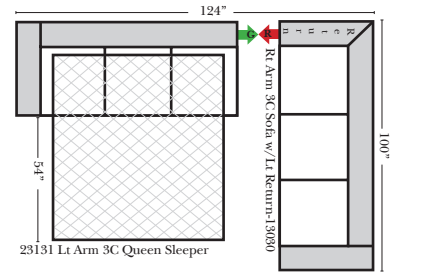

Standard & options

Standard:

- Available in Full & Top Grain Leathers
- Available in Luxury Fabrics
- All Hardwood Frames
- Nail Heads - Brass
- Wood Leg Finish (Standard is Walnut)

Options: (No Additional Charge)

- No. 33 Firm Foam Cushions
- Wood Leg Finish (Available in Cherry, Chocolate, Espresso, Honey Oak, & Shadow)

Options: (Additional Charge)

- Down Seats & Down Backs
- Upholstered Swivel Base (2 arm Chair Only)

L-Shape / 90 Degree Sectional (All 4 seat items ship as one piece if stationary)

Put Green Arrows with Red Arrows to Create Sectional Groups

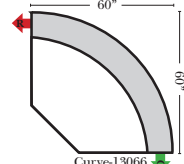
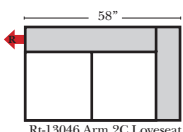
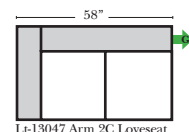
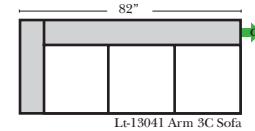
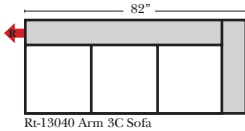
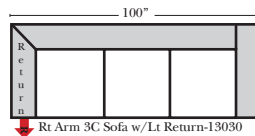
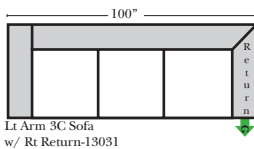

Sleepers

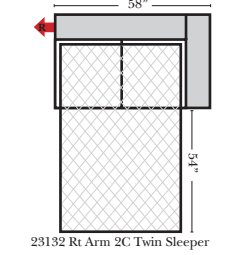
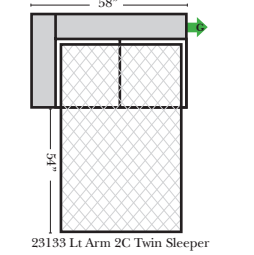
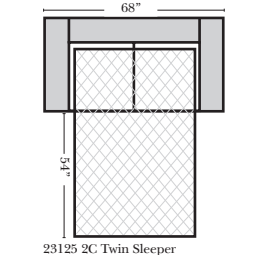
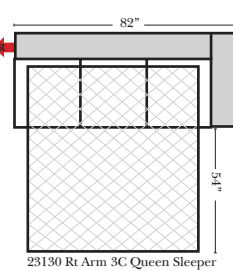
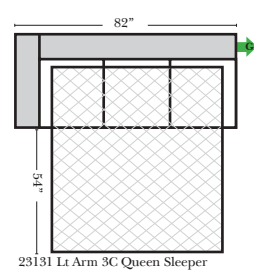
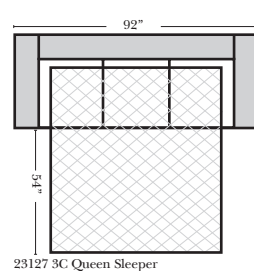

Sleeper Options: (All the below options are at additional charges)

- Queen Sleeper available w/Standard Mattress
- Twin Sleeper available w/Standard Mattress
- Deluxe Innerspring Mattress: Queen / Twin
- Air Dream Coil Mattress: Queen Only - (No Twin)
- Hideaway Air Mattress: Queen Only (Shipped in a Separate Box)



Note:

All Dimensions are approximate, if accuracy is crucial, please contact us for validation of the dimensions shown. However, a 1" to 2" variance can still apply due to foam and upholstery.